

CLEVERBOX WINDOW INTEGRATED SYSTEM

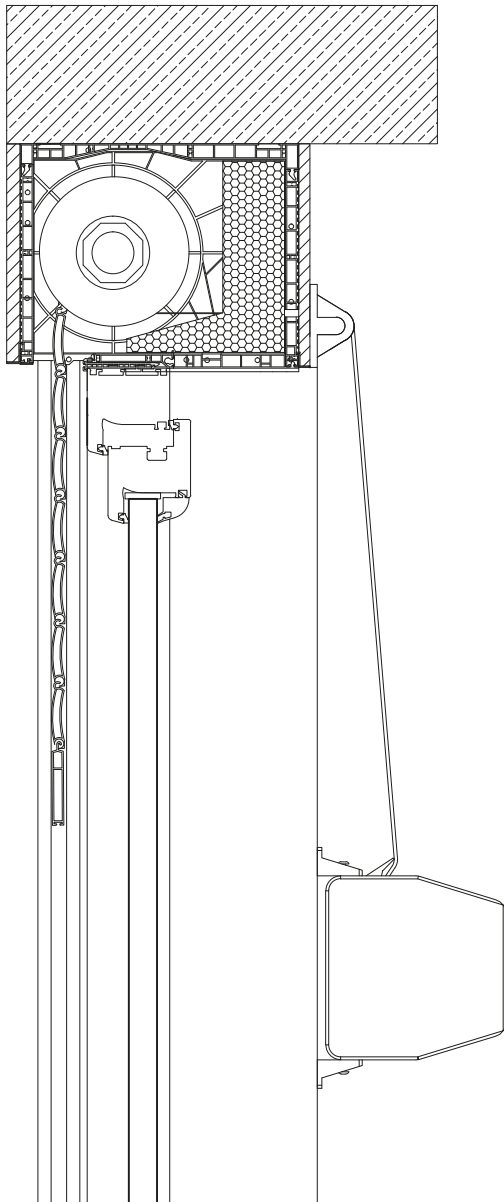

CBR 165x255

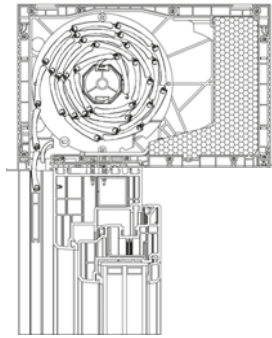

CBR 205x255

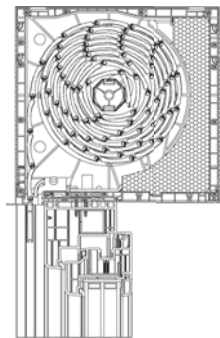

CBR 245x255

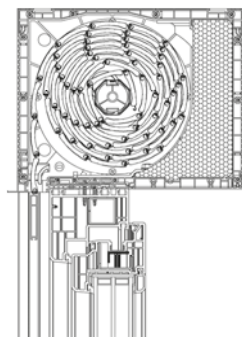

CBR 165x175

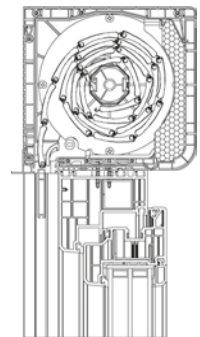

CBR 205x215

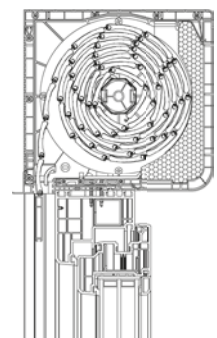

maximal shutter height including box

box size	PA39	
	SW40	SW60
165x255	2000	1800
205x255	3200	3000
245x255	4000	3800
165x175	2000	1800
205x215	3400	3200

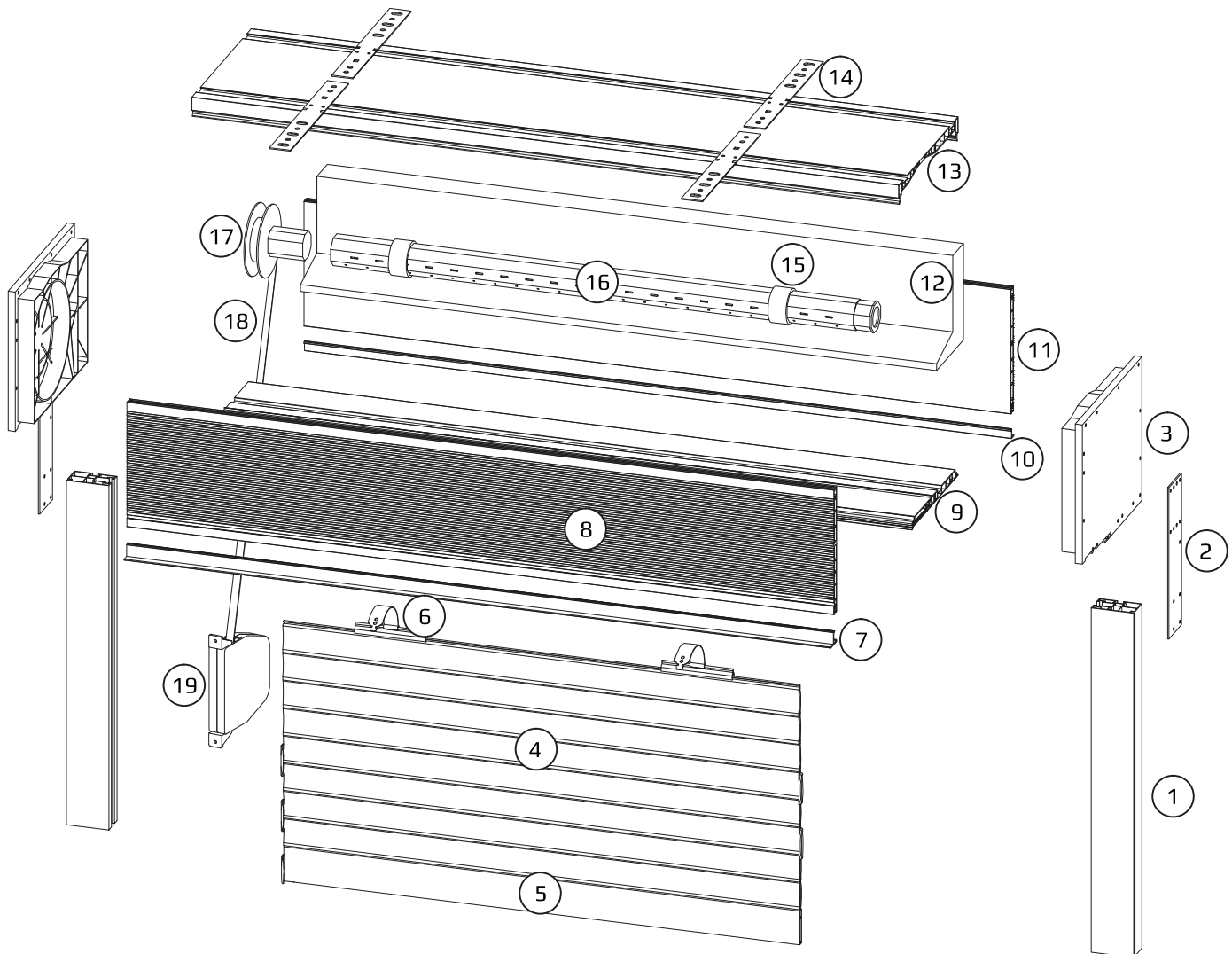

- 1 - PG guide channel
- 2 - CBAF 00 – box to window frame mounting
- 3 - CBAE 10 -side wall of the box
- 4 - curtain
- 5 - end slat
- 6 - steel hanger
- 7 - CBCP 00 bottom profile of the box
- 8 - CBPF 10 front profile of the box
- 9 - CBPC 00 – window integration profile

- 10 - CBPA – bottom profile
- 11 - CBPF 10 – back profile of the box
- 12 - CBAH 10 box insulation
- 13 - CBPT 00 – top profile of the box
- 14 - CBAF 01 – mounting profile
- 15 - diameter extension ring
- 16 - octagonal tube
- 17 - KNO – winding wheel with tube connector
- 18 - tape/cord
- 19 - coiler

CLEVERBOX WINDOW INTEGRATED SYSTEM WITH INSECT SCREEN

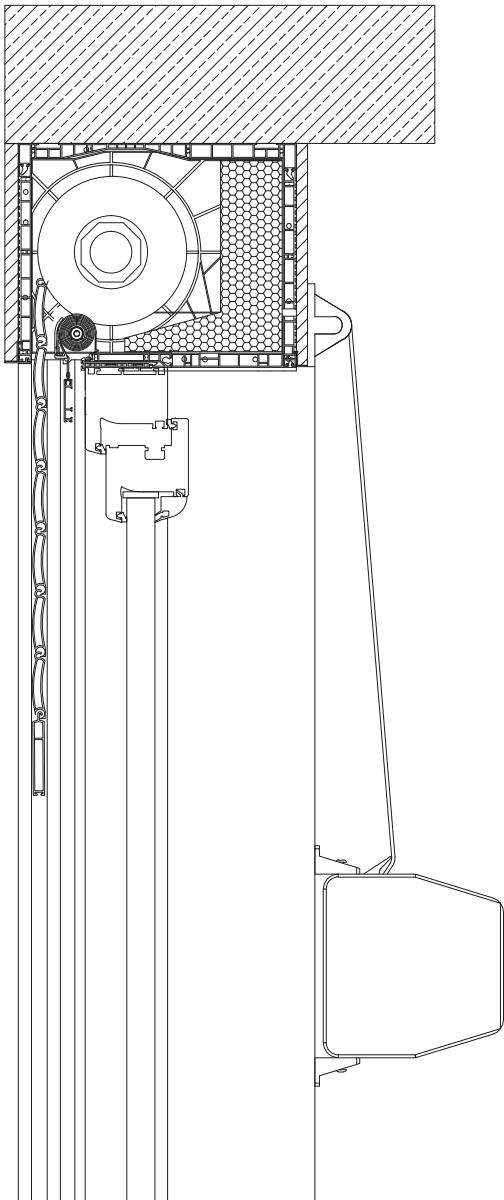

CBR 165x255 I

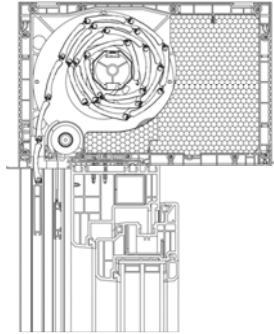

CBR 165x175 I

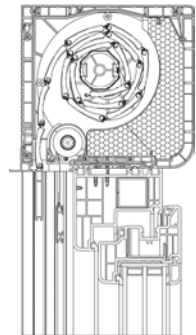

CBR 205x255 I

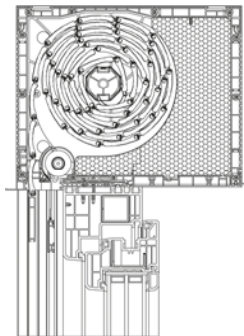

CBR 205x215 I

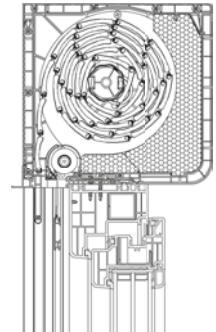

CBR 245x255 I

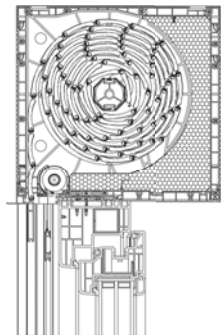

maximal roller shutter height including box

box size	PA39	
	SW40	SW60
165x255	1400	1200
205x255	2400	2400
245x255	2400	2400
165x175	1400	1200
205x215	2400	2200

WINDOW INTEGRATED SYSTEM CLEVERBOX + INSECT SCREEN - COMPONENTS

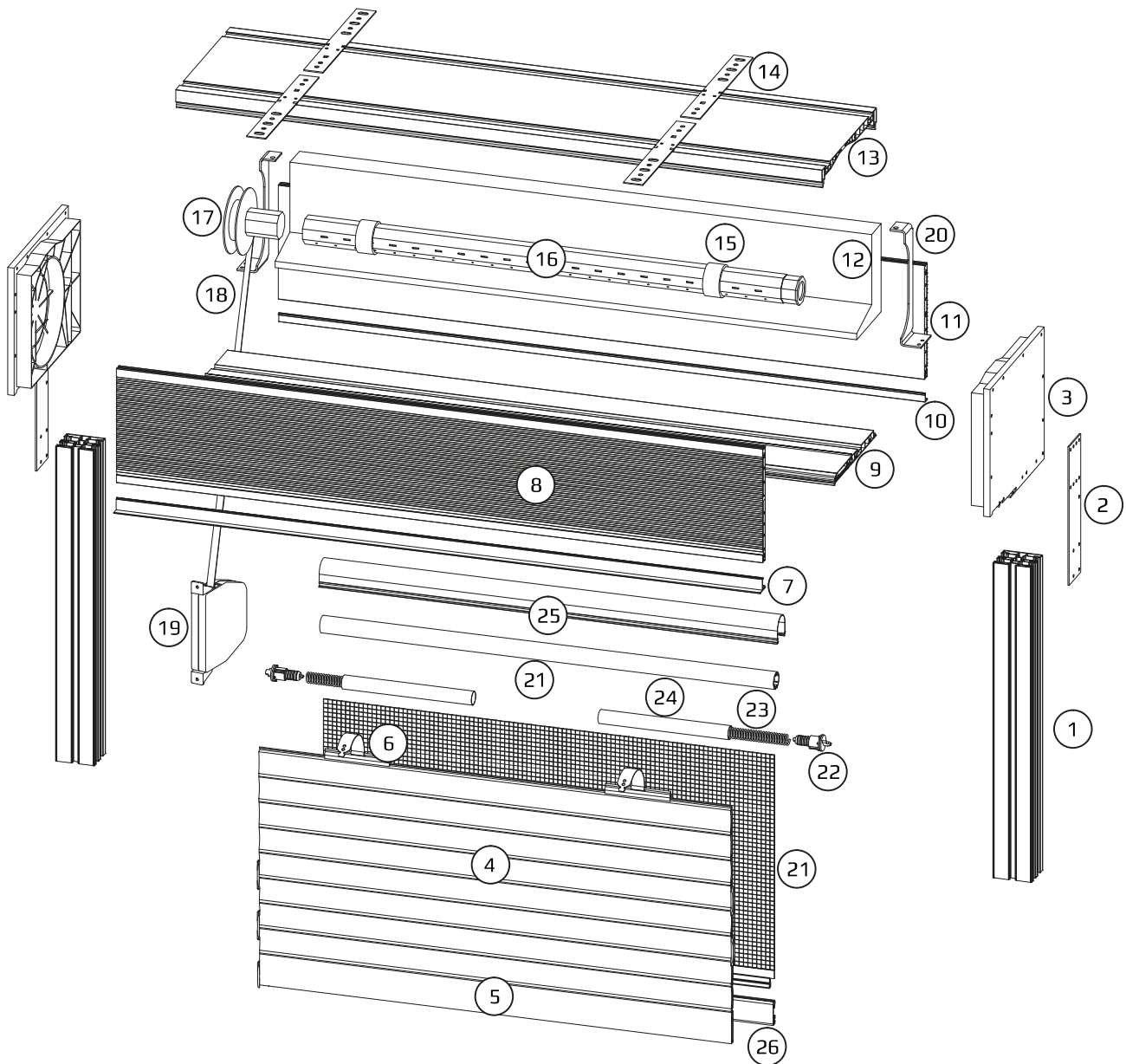

- | | |
|--|--|
| 1 - PG guide channel | 13 - CBPT 00 - top profile of the box |
| 2 - CBAF 00 - box to window frame mounting | 14 - CBAF 01 - mounting profile |
| 3 - CBAE 10 - side wall of the box | 15 - diameter extension ring |
| 4 - curtain | 16 - octagonal tube |
| 5 - end slat | 17 - KNO - winding wheel with tube connector |
| 6 - steel hanger | 18 - tape/cord |
| 7 - CBCP 00 bottom profile of the box | 19 - coiler |
| 8 - CBPF 10 front profile of the box | 20 - CBAR - stiffening profile |
| 9 - CBPC 00 - window integration profile | 21 - CBAN - insect screen with tube |
| 10 - CBPA - bottom profile | 22-24 - CBAD - spring mechanism |
| 11 - CBPF 10 - back profile of the box | 25 - CBAW 00 - insect screen cover |
| 12 - CBAH 10 - box insulation | 26 - CBAZ 00 - mosquito net end slat |